

The type 5013 is a steel compression load cell for force and weight measurement.

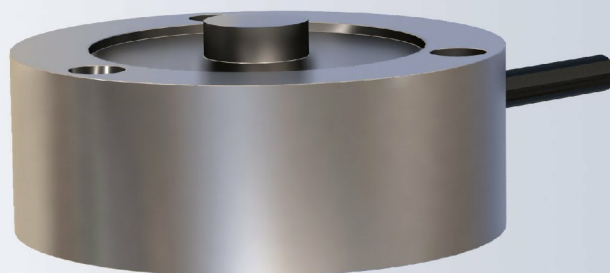

IP67

FEATURES

- Capacities from 1t to 100t.
- Alloy steel construction.
- Environmental Protection IP67.

APPLICATIONS

- Force and weight measurement.

OPTIONS

- Service temperature range up to 120°C.
- 6 wire circuit.
- Stainless steel version.

OUTLINE DIMENSIONS

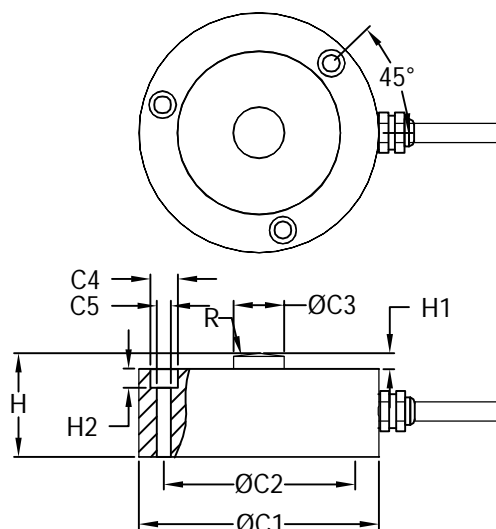

Capacity (t)	C1	C2	C3	C4	C5	H	H1	H2	R
5	2.36 [60.0]	2.05 [52.0]	0.37 [9.5]	0.24 [6.0]	0.13 [3.2]	0.94 [24.0]	0.16 [4.0]	0.11 [3.0]	1.18 [30.0]
10	2.50 [63.6]	2.17 [55.0]	0.53 [13.5]	0.28 [7.2]	0.17 [4.2]	1.02 [26.0]	0.16 [4.0]	0.20 [5.0]	3.94 [100.0]
25	2.99 [75.9]	2.60 [66.0]	0.80 [20.3]	0.28 [7.0]	0.19 [4.8]	1.50 [38.1]	0.18 [4.6]	0.20 [5.0]	5.91 [150.0]
50	4.13 [105.0]	3.54 [90.0]	1.18 [30.0]	0.43 [11.0]	0.28 [6.5]	2.09 [53.0]	0.28 [7.0]	0.28 [7.0]	9.84 [250.0]
100	4.84 [123.0]	3.86 [98.0]	1.69 [43.0]	0.59 [15.0]	0.41 [10.5]	3.74 [95.0]	0.59 [15.0]	0.47 [12.0]	14.96 [380.0]



canisters and disks 5013

Mounting Hardware for 5013 Load Cell (F276) :

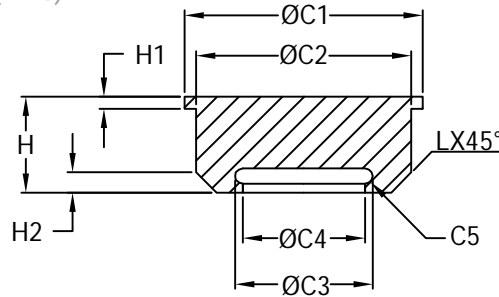
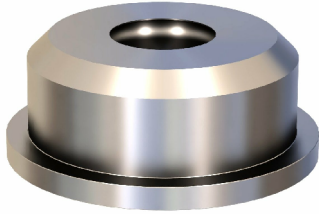

IS SEPARATED 4mm THE VEHICLE
0.5X0.5 SHALLOW GRAIN

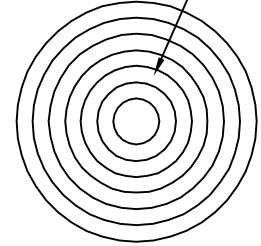

Capacity (t)	C1	C2	C3	C4	C5	H	H1	H2	L
5	1.30 [33.0]	1.06 [27.0]	0.47 [12.0]	0.39 [10.0]	0.04 [1.0]	0.51 [13.0]	0.12 [3.0]	0.11 [2.9]	0.12 [3.0]
10	1.61 [41.0]	1.38 [35.0]	0.62 [15.8]	0.54 [13.8]	0.04 [1.0]	0.63 [16.0]	0.12 [3.0]	0.11 [2.9]	0.16 [4.0]
25	1.93 [49.0]	1.69 [43.0]	0.92 [23.3]	0.81 [20.5]	0.06 [1.4]	0.75 [19.0]	0.12 [3.0]	0.15 [3.9]	0.20 [5.0]
50	2.83 [72.0]	2.60 [66.0]	1.36 [34.6]	1.22 [31.0]	0.07 [1.8]	1.42 [36.0]	0.12 [3.0]	0.22 [5.7]	0.20 [5.0]
100	3.15 [80.0]	2.91 [74.0]	2.13 [54.0]	1.73 [44.0]	0.20 [5.0]	1.97 [50.0]	0.12 [3.0]	0.49 [12.4]	0.28 [7.0]

SPECIFICATIONS

Model	5013	
Capacities	t	5/ 10/ 25/ 50/ 100
Full scale output (FS)	mV/V	2.5±10%
Non-linearity	%FS	≤±0.32
Hysteresis	%FS	≤±0.32
Non- repeatability	%FS	≤±0.05
Creep @ 30min	%FS	≤±0.10
Zero balance	mV/V	±0.05
Temperature range		
Operating	°C	-10... +40
Bridge resistance	Ω	350±3
Excitation voltage	V (DC/AC)	18... 25
Insulation resistance @50V DC	MΩ	≥2000
Safe overload limit	%FS	150
Ultimate load	%FS	300
Cable length	m	6 (Capacity≤10t) 10(Capacity≥20t)
Seal type	IP67	
Element material	Alloy steel	

WIRING

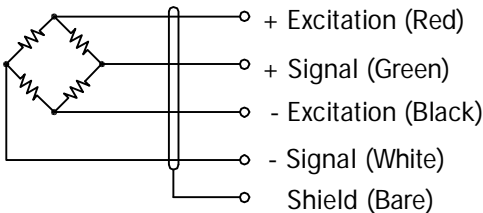

Cable : Ø5.1mm 4 Conductor cable.

PART NUMBERS

Capacity (t)	Part#
5	5013-000-00
10	5013-001-00
25	5013-002-00
50	5013-003-00
100	5013-004-00

Dimensions and specifications subject to change without notice