

Explore the full potential of our digital load cells with our specially developed interconnect cable kit. This cable kit establishes accurate and high-speed connection between our digital load cells and your PLC or PC. It also helps in precise setting of digital load cells using our DOP4 software.



IP67

FEATURES

- Easy connection of Group Four digital load cell with PLC or PC
- Allows IP67 waterproof connection
- Shock & vibration resistant
- RoHS compliant
- Environmental protection IP67
- Interconnects M8 daisy chained cabling with PLC or PC

APPLICATIONS

- Digital load cell weighing systems

OPTIONS

- RS485/RS422 to USB converter (PN : XS890)
- Customized cable lengths and configurations

M8 A CODING 8P MALE TO OPEN CABLE

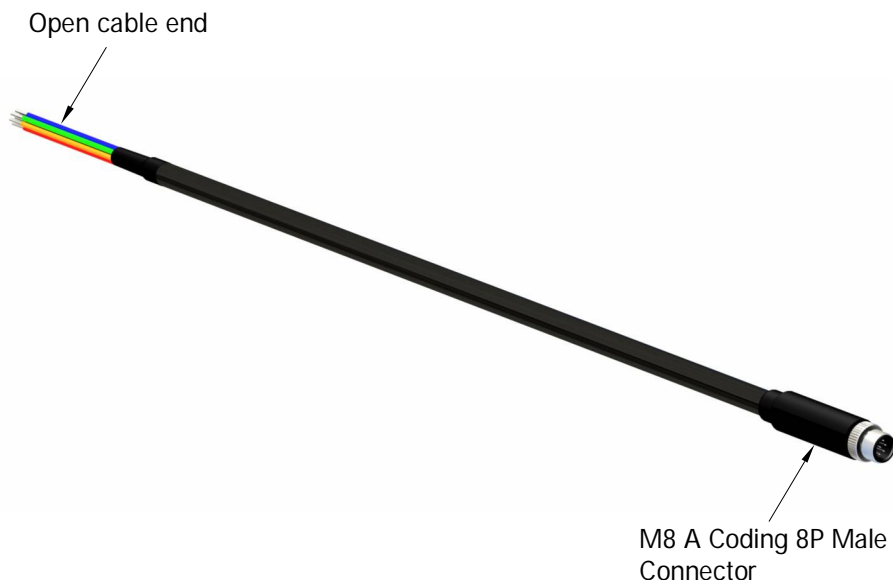

Part Number Selection Table for Different Cable Lengths

Option	Cable Length	Part No.
GEN	5m	M8 male connector cable
A	10m	M8 male connector cable-A
B	16in	M8 male connector cable-B
C	64in	M8 male connector cable-C

Interconnect Cable Kit

M8 A CODING 8P MALE TO 8P FEMALE CABLE

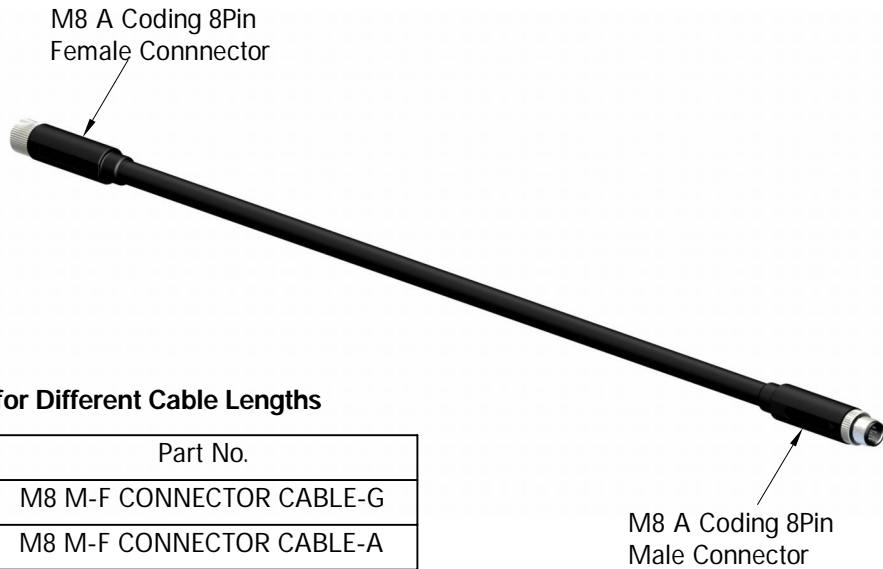

Part Number Selection Table for Different Cable Lengths

Option	Cable Length	Part No.
GEN	18in	M8 M-F CONNECTOR CABLE-G
A	5m	M8 M-F CONNECTOR CABLE-A
B	10m	M8 M-F CONNECTOR CABLE-B

M8 A CODING 8P FEMALE TO DB9 FEMALE CONNECTOR CABLE WITH POWER CONNECTOR

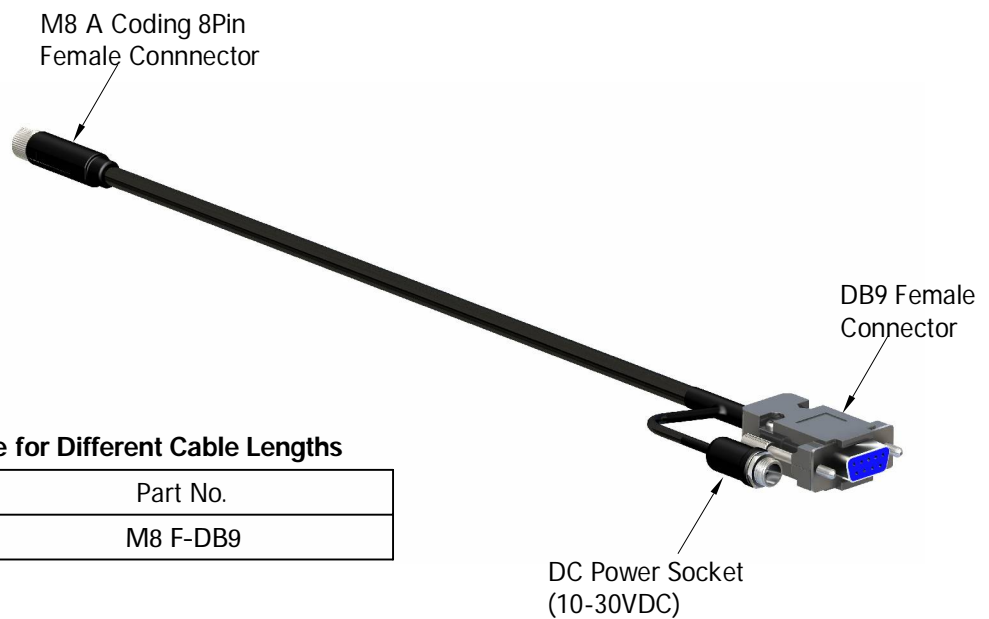

Part Number Selection Table for Different Cable Lengths

Cable Length	Part No.
6±0.5ft	M8 F-DB9

accessories

Interconnect Cable Kit

COMPLETE CABLE ASSEMBLY OF INTERCONNECT CABLE KIT

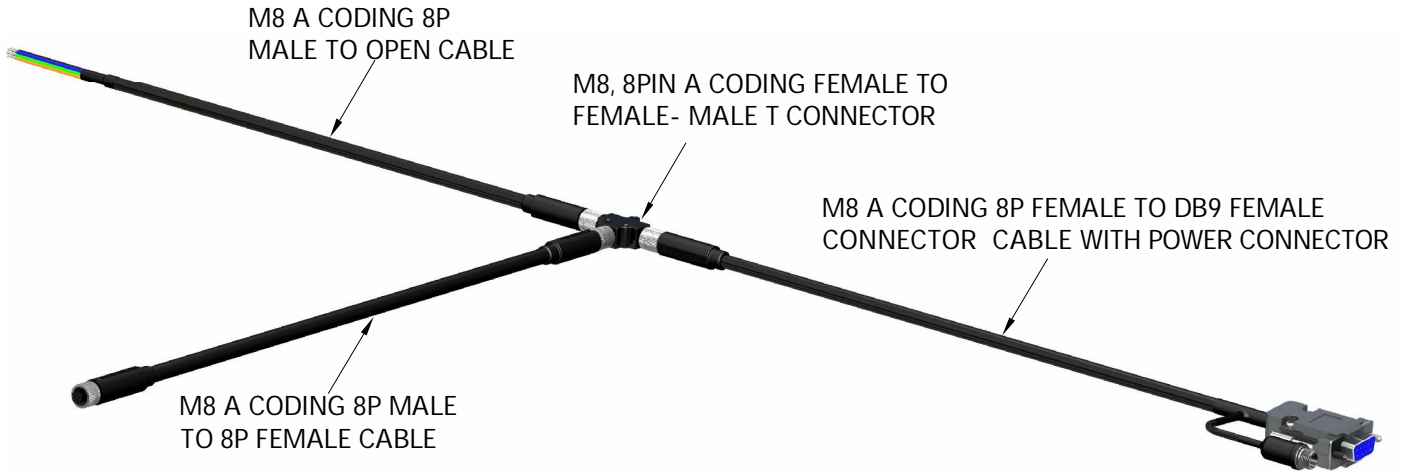

APPLICATION

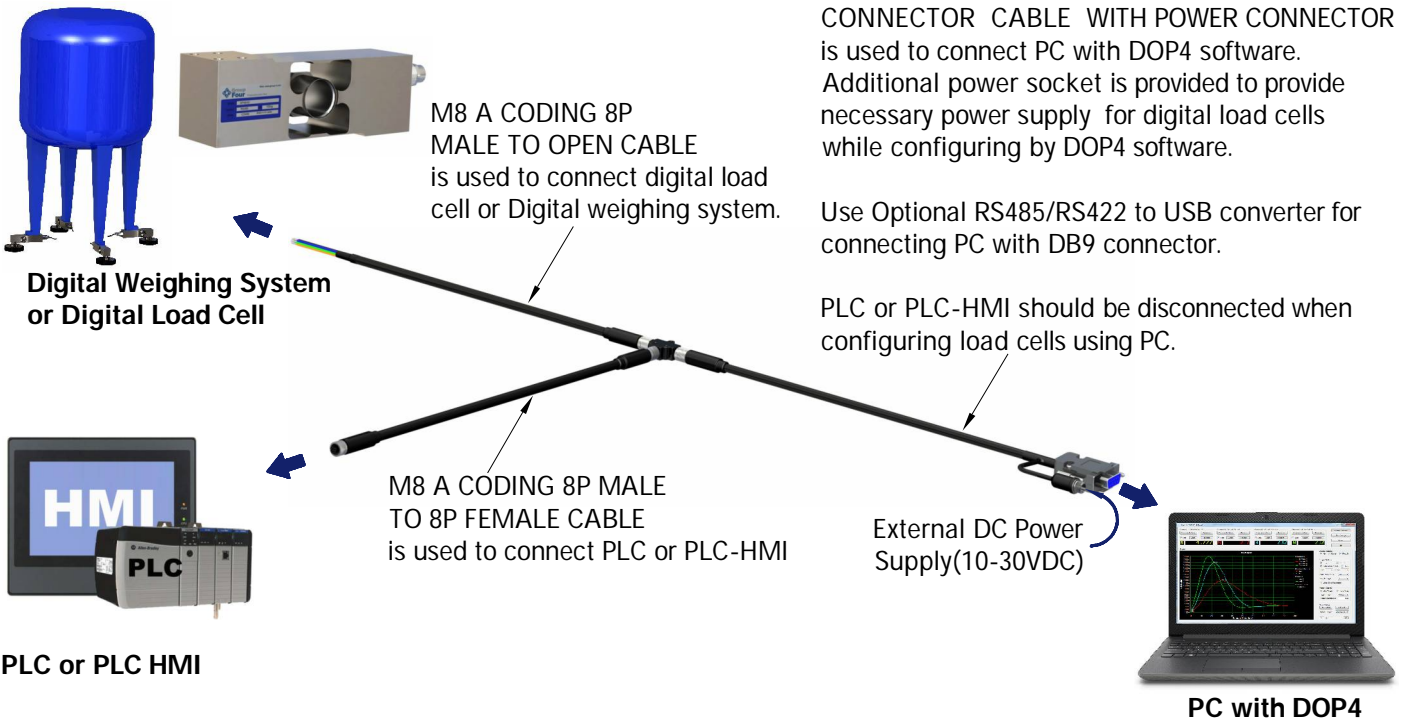

Group Four Transducers
22 Deer Park Drive,
E. Longmeadow, MA 01028
www.groupfourtransducers.com

Phone : (800) 419 1444
Fax : (413) 525 -6182
sales@group-4.com

accessories

Interconnect Cable Kit

DB9 FEMALE CONNECTOR PIN CONFIGURATION

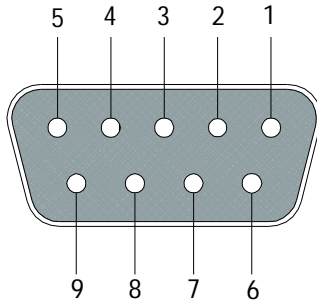

Pin No.	RS-422	Color
1	Rx+	Green
2	Rx-	Gray
3	Tx+	Blue
4	Tx-	Pink
5	GND	White

M8 CONNECTOR PIN CONFIGURATION

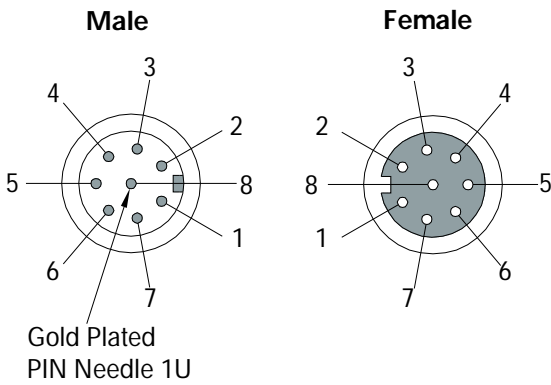

Pin No.	Color	RS-232/CAN	RS-485/ RS-422
1	White	GND1	GND1
2	Brown	PROGRAM	PROGRAM
3	Green	CANH	Rx+
4	Yellow	TRIGGER INPUT	TRIGGER INPUT
5	Gray	CANL	Rx-
6	Pink	RxD	Tx-
7	Blue	TxD	Tx+
8	Red	PWR+	PWR+



SPECIFICATIONS

M8 CABLES AND CONNECTORS		
Rating Voltage	V	30
Rating Current	A	1.5
Contact Resistance of Connector	mΩ	≤10
Cable	24 AWG, Black PVC cable	
Operating Temperature	°C	-25... +85
Insulation Resistance	MΩ	≥100
Mechanical Characteristics Mating /Cycles	Cycle	>100
Destructive Withstand Force Between Connector	kgf	2
Water Proof Connector Rating	IP67	

Dimensions and specifications subject to change without notice



Pioneering Measured Solutions

Group Four Transducers
22 Deer Park Drive,
E. Longmeadow, MA 01028
www.groupfourtransducers.com

Phone : (800) 419 1444
Fax : (413) 525 -6182
sales@group-4.com